

Switchboard

3Phase 10-40Kva

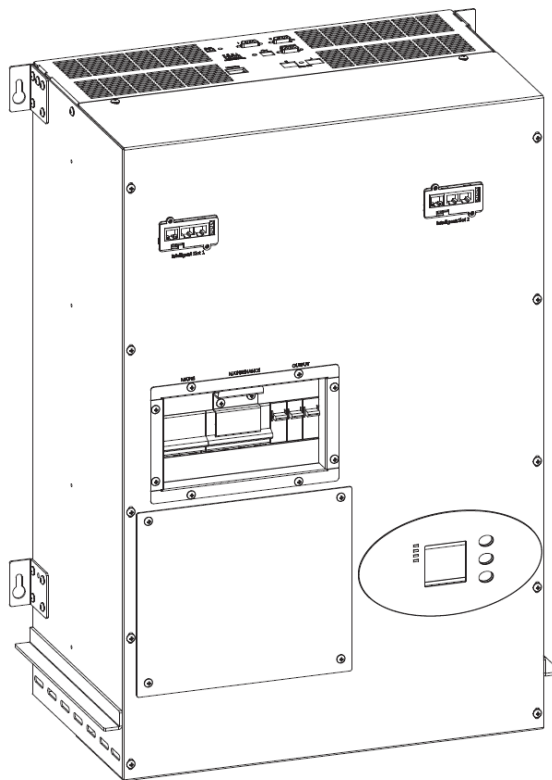
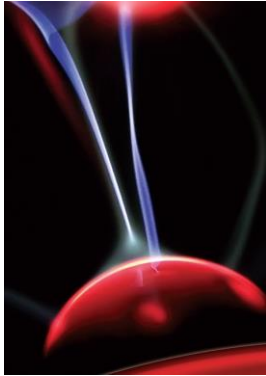

Electrical System for Continuity

Contents

1. Safety	3
1.1 Safety notes.....	3
1.2 Symbols used in this guide.....	3
2. Main Features	3
2.1 Summarization.....	3
2.2 Functions and Features.....	3
3. Installation	4
3.1 Unpack checking.....	4
3.2 Cabinet Outlook.....	4
3.3 Display control panel.....	6
3.4 Installation notes.....	6
3.5 External Protective Devices.....	7
3.6 Power Cables.....	7
3.7 Power cable connect.....	8
3.8 Battery connection.....	9
3.9 UPS parallel Installation.....	10
3.10 Computer access (CD MUSER4000 optional).....	11
4. Operation	12
4.1 Operation Modes.....	12
4.2 Turn on/off UPS.....	12
4.3 The TFT Color Display.....	17
4.4 Parameters Display & Setting.....	20
4.5 Display Messages/Troubleshooting.....	22
4.6 Options.....	23
Appendix 1 Specifications	25
Appendix 2 Problems and Solution	27
Appendix 3 USB communication port definition	28
Appendix 4 RS232 communication port definition	28
Appendix 5 RS485 communication port definition	29
Appendix 6 Optocoupler contact communication port definition	29
Appendix 7 REPO instruction	30
Appendix 8 Accessories	30
Appendix 9 Efficiency Chart	31
Warranty	32

Publish statement

Thank you for purchasing this series UPS.

This series UPS is an intelligent, three phase in Three phase out, high frequency online UPS designed by our R&D team who is with years of designing experiences on UPS. With excellent electrical performance, perfect intelligent monitoring and network functions, smart appearance, complying with EMC and safety standards, The UPS meets the world's advanced level.

Read this manual carefully before installation

This manual provides technical support to the operator of the equipment.

Made in P.R.C



All rights reserved.

The information in this document is subject to change without notice.

1. SAFETY

Important safety instructions - Save these instructions

There exists dangerous voltage and high temperature inside the UPS. During the installation, operation and maintenance, please abide the local safety instructions and relative laws, otherwise it will result in personnel injury or equipment damage. Safety instructions in this manual act as a supplementary for the local safety instructions. Our company will not assume the liability that caused by disobeying safety instructions.

1.1 Safety notes

1. Even no connection with utility power, 220/230/240VAC voltage may still exist at UPS terminal !
2. For the sake of human being safety, please well earth the UPS before starting it.
3. Don't open or damage battery, for the liquid spilled from the battery is strongly poisonous and do harmful to body!
4. Please avoid short circuit between anode and cathode of battery, otherwise, it will cause spark or fire!
5. Don't disassemble the UPS cover, or there may be an electric shock!
6. Check if there exists high voltage before touching the battery
7. Working environment and storage way will affect the lifetime and reliability of the UPS. Avoid the UPS from working under following environment for long time
 - ◆ Area where the humidity and temperature is out of the specified range(temperature 0 to 40°C, relative humidity 5%-95%)
 - ◆ Direct sunlight or location nearby heat
 - ◆ Vibration Area with possibility to get the UPS crashed.
 - ◆ Area with erosive gas, flammable gas, excessive dust, etc
8. Keep ventilations in good conditions otherwise the components inside the UPS will be over-heated which may affect the life of the UPS.

1.2 Symbols used in this guide



WARNING! Risk of electric shock



CAUTION! Read this information to avoid equipment damage

2. MAIN FEATURES

2.1 Summarization

This series UPS is a kind of three-in-three-out high frequency online UPS.

The UPS can solve most of the power supply problems, such as blackout, over-voltage, under-voltage, voltage sudden drop, oscillating of decreasing extent, high voltage pulse, voltage fluctuation, surge, inrush current, harmonic distortion (THD), noise interference, frequency fluctuation, etc..

This UPS can be applied to different applications from computer device, automatic equipment, communication system to industry equipment.

2.2 Functions and Features

- ◆ 3Phase In/3Phase Out UPS
It is 3Phase In/3Phase Out high-density UPS system, of which input current is kept in balance. No unbalance problem might occur.
- ◆ Digital Control
This series UPS is controlled by Digital Signal Processor (DSP); enhance, it increases reliability, performance, self-protection, and self-diagnostics and so on.
- ◆ Battery Configurable
10-30kVA: from 16 blocks to 20 blocks, the battery voltage of this series UPS can be configured at 16 blocks, 18 blocks or 20 blocks according to your convenience.
40kVA: from 32 blocks to 40 blocks, the battery voltage of this series UPS can be configured at 32 blocks, 34 blocks, 36 blocks, 38 blocks or 40 blocks according to your convenience.

- ◆ **Charging Current is configurable**
Via setting tool, the user may set the capacity of the batteries as well as reasonable charging current as well as maximum charging current. Constant voltage mode, constant current mode or floating mode can be switched automatically and smoothly.
- ◆ **Intelligent Charging Method**
The series UPS adopts advanced three-stage charging method:
 - 1st stage: high current constant current charging to guarantee to charge back to 90%;
 - 2nd-stage: Constant Voltage in order to vitalize battery and make sure batteries are fully charged
 - 3rd stage: floating mode.With this 3-stage charging method, it extends the life of the batteries and guarantees fast charging.
- ◆ **LCD Display**
With LCD plus LED displays, the user may easily get UPS status and its operational parameters, such as input/output voltage, frequency & load%, battery % and ambient temperature, etc...
- ◆ **Intelligent Monitoring Function**
Via optional SNMP Card, you may remotely control and monitor the UPS.
- ◆ **EPO Function**
The series UPS may be completely shut off when the EPO is pressed. REPO function (Remote EPO) is also available in this series UPS.

3. INSTALLATION

3.1 Unpack checking

1. Don't lean the UPS when moving it out from the packaging
2. Check the appearance to see if the UPS is damaged or not during the transportation, do not switch on the UPS if any damage found. Please contact the dealer right away.
3. Check the accessories according to the list at Appendix 8 and contact the dealer in case of missing parts.

3.2 Cabinet Outlook

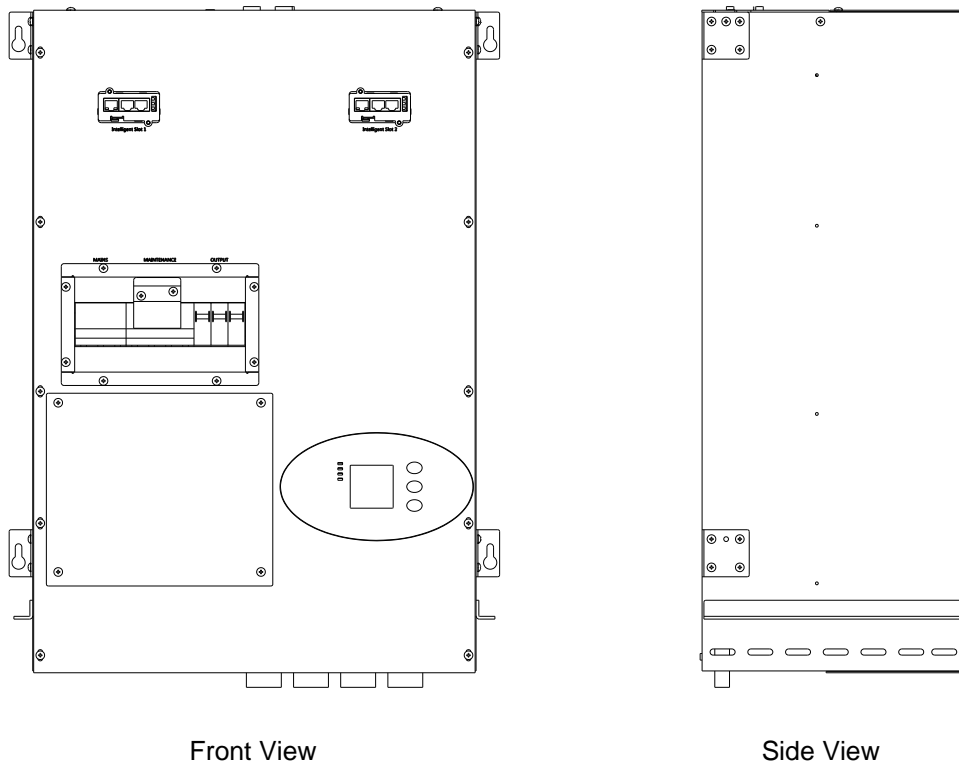

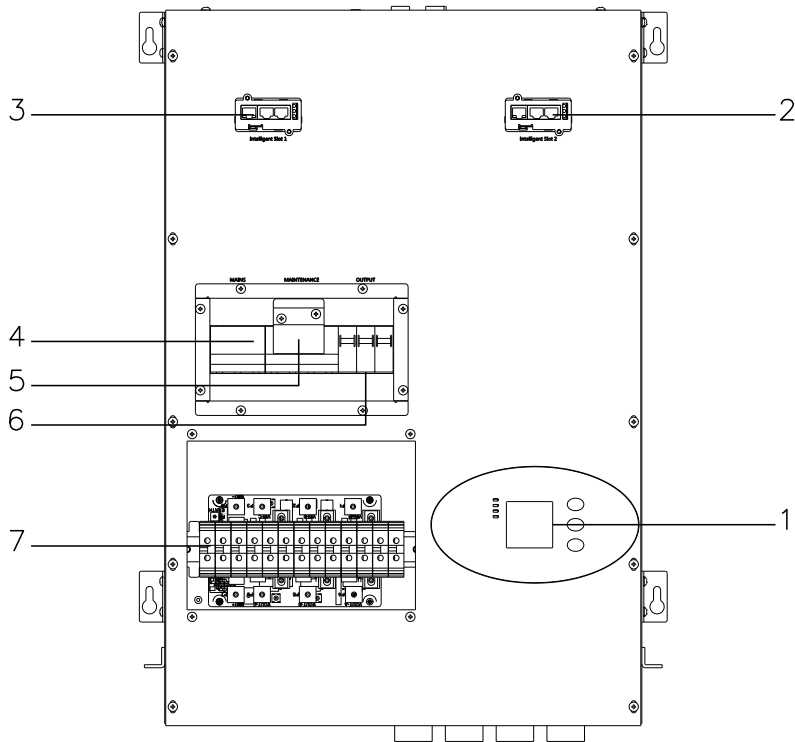

10-40KVA Front View (terminal block without cover)

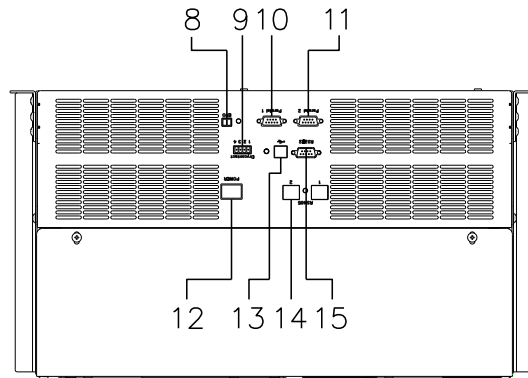

10-40KVA Bottom View

- 1) TFT color display panel
- 2) Intelligent Slot 2 (SNMP card/ Relay card)
- 3) Intelligent Slot 1 (SNMP card/ Relay card)
- 4) I/P Switch
- 5) Maintenance switch & its cover
- 6) O/P Switch
- 7) Terminal block for Input, output & battery
- 8) REPO port
- 9) Dry contact port
- 10) Parallel port 1
- 11) Parallel port 2
- 12) Power Switch
- 13) USB port
- 14) RS485 port
- 15) RS232 port

3.3 Display control panel

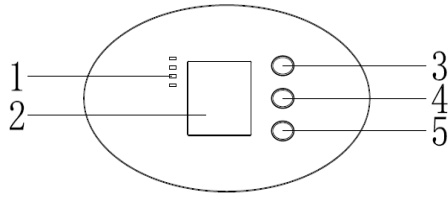

- 1) LED (from top to bottom: alarm / bypass / battery / inverter")
- 2) TFT color display
- 3) Scroll button
- 4) Off button
- 5) On button (battery cold start switch)

3.4 Installation notes

Note: Consider for the convenience of operation and maintenance, the space in front and side of the cabinet should be left at least 100cm and 80cm respectively when installing the cabinet.

- ◆ Please place the UPS in a clean, stable environment, avoid the vibration, dust, humidity, flammable gas and liquid, corrosive. To avoid from high room temperature, a system of room extractor fans is recommended to be installed. Optional air filters are available if the UPS operates in a dusty environment.
- ◆ The environment temperature around UPS should keep in a range of 0°C~40°C. If the environment temperature exceeds 40°C, the rated load capacity should be reduced by 12% per 5°C. The max temperature can't be higher than 50°C.
- ◆ If the UPS is dismantled under low temperature, it might be in a condensing condition. The UPS can't be installed unless the internal and external of the equipment is fully dry. Otherwise, there will be in danger of electric shock.
- ◆ Batteries should be mounted in an environment where the temperature is within the required specs. Temperature is a major factor in determining battery life and capacity. In a normal installation, the battery temperature is maintained between 15°C and 25°C. Keep batteries away from heat sources or main air ventilation area, etc.



WARNING!

Typical battery performance data are quoted for an operating temperature between 20°C and 25°C. Operating it above this range will reduce the battery life while operation below this range will reduce the battery capacity.

- ◆ Should the equipment not be installed immediately it must be stored in a room so as to protect it against excessive humidity and or heat sources.



CAUTION!

An unused battery must be recharged every 6months Temporarily connecting the UPS to a suitable AC supply mains and activating it for the time required for recharging the batteries.

- ◆ The highest altitude that UPS may work normally with full load is 1500 meters. The load capacity should be reduced when this UPS is installed in place whose altitude is higher than 1500 meters, shown as the following table:

(Load coefficient equals max load in high altitude place divided by nominal power of the UPS)

Altitude (Mt)	1500	2000	2500	3000	3500	4000	4500	5000
Load coefficient	100%	95%	90%	85%	80%	75%	70%	65%

- ◆ The UPS cooling is depending on fan, so it should be kept in good air ventilation area. There are many ventilation holes on the front and rear, so they should not be blocked by any obstacles.

3.5 External Protective Devices

For safety reasons, it is necessary to install, external circuit breaker at the input A.C. supply and the battery. This chapter provides guidelines for qualified installers that must have the knowledge of local wiring practices for the equipment to be installed.

◆ **External Battery**

The UPS and its associated batteries are protected against the effect of over-current through a DC compatible thermo-magnetic circuit-breaker (or a set of fuses) located close to the battery.

◆ **UPS Output**

Any external distribution board used for load distribution shall be fitted with protective devices that may avoid the risk of UPS overloaded.

◆ **Over-current**

Protection device shall be installed at the distribution panel of the incoming main supply. It may identify the power cables current capacity as well as the overload capacity of the system.



CAUTION!

Select a thermo magnetic circuit-breaker with an IEC 60947-2 trip curve C (normal) for 125% of the current as listed below.

3.6 Power Cables

- ◆ The cable design shall comply with the voltages and currents provided in this section, Kindly follow local wiring practices and take into consideration the environmental conditions (temperature and physical support media).



WARNING!

Upon starting. Please ensure that you are aware of the location and operation of the external isolators which are connected to the UPS input/bypass supply of the mains distribution panel. Check to see if these supplies are electrically isolated. And post and necessary warning signs to prevent any inadvertent operation.

- ◆ For future expansion purpose, it is economical to install power cable according to the full rating capacity initially. The diameter of cable is shown below:

UPS	CABLE DIMENSION (mm ²)			
	AC Input	AC Output	DC Input	Ground
10KVA	4 x 10	4 x 10	10	10
15KVA	4 x 10	4 x 10	16	10
20KVA	4 x 16	4 x 16	20	16
30KVA	4 x 16	4 x 16	3 x 35	16
40KVA	4 x 16	4 x 16	3 x 16	16



CAUTION!

Protective earth cable: Connect each cabinet to the main ground system. For Grounding connection, follow the shortest route possible.



WARNING!

Failure to follow adequate earthing procedures may result in electromagnetic interference or in hazards involving electric shock and fire

UPS - TABLE BREAKERS

UPS MODEL	10KVA	15KVA	20KVA	30KVA	40KVA
INPUT breaker	3P 20A/400Vac	3P 32A/400Vac	3P 40A/400Vac	3P 63A/400Vac	3P 80A/400Vac
OUTPUT breaker	3P 20A/400Vac	3P 32A/400Vac	3P 40A/400Vac	3P 63A/400Vac	3P 100A/400Vac
BY-PASS breaker	4P 63A/400Vac			3P 63A/400Vac	3P 100A/400Vac
Internal Battery Fuse	63A/500Vdc	100A/500Vdc	120A/500Vdc	200A/500Vdc	

3.7 Power cable connect

Once the equipment has been finally positioned and secured, connect the power cables as described in the following procedure.

Verify the UPS is totally isolated from its external power source and also all power isolators of the UPS are open. Check to see if they are electrically isolated, and post any necessary warning signs to prevent their inadvertent operation. Remove the cover of terminals for wiring easily.

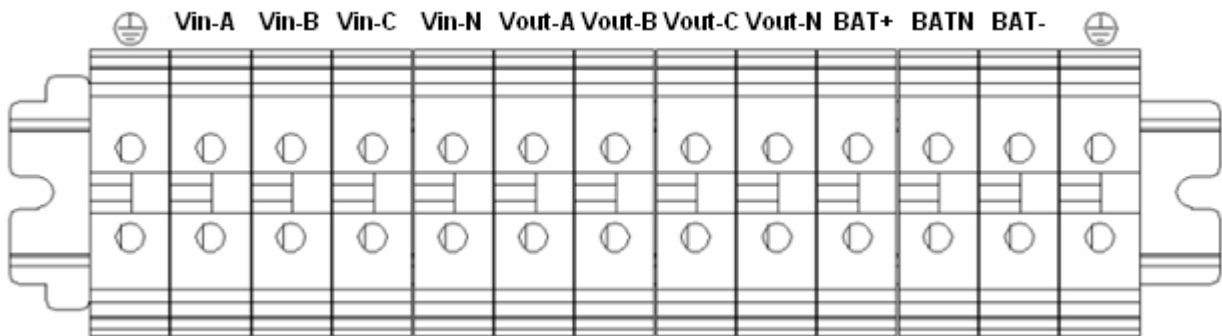

Terminal sequence from left to right:

Ground, Input phase A(L1), input phase B(L2), input phase C(L3), input Neutral line, output phase A(L1), output phase B(L2), output phase C(L3), output Neutral line, battery positive, battery Neutral, battery negative, Ground

Choose appropriate power cable. (Refer to the table above) and pay attention to the diameter of the connection terminal of the cable that should be greater than or equal to that of the connection poles;

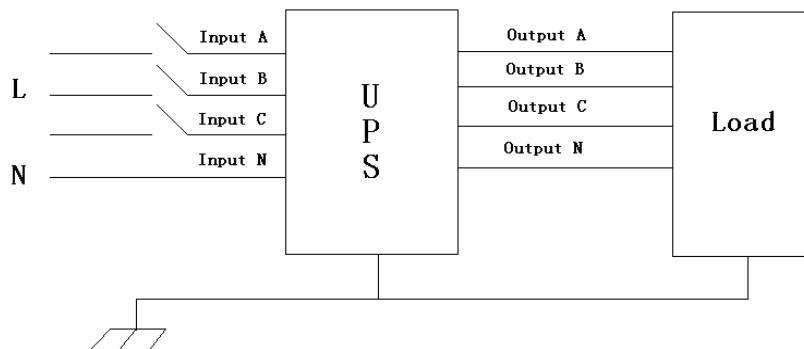



WARNING!

If the load equipment is not ready to accept power on the arrival of the commissioning engineer then ensure that the system output cables are safely isolated at their ends. Connect the safety earth and any necessary bonding earth cables to the copper earth screw located on the floor of the equipment below the power connections. All cabinets in the UPS must be grounded properly.



CAUTION!

The earthing and neutral bonding arrangement must be in accordance with local and national codes of practice.

3.8 Battery connection

10-30KVA: The UPS adopts positive and negative double battery framework, totally 20pcs (optional 16/18) in series. A neutral cable is retrieved from the joint between the cathode of the 10th (8th/9th) and the anode of the 11th (9th/10th) of the batteries.

40KVA: The UPS adopts positive and negative double battery framework, totally 40pcs (optional 32/34/36) in series. A neutral cable is retrieved from the joint between the cathode of the 20th (17th/18th/19th) and the anode of the 21th (18th/19th/20th) of the batteries.

Then the neutral cable, the battery Positive and the battery negative are connected with the UPS respectively. The battery sets between the Battery anode and the neutral are called positive batteries and that between neutral and cathode are called negative ones.

External battery connections for long-run units:

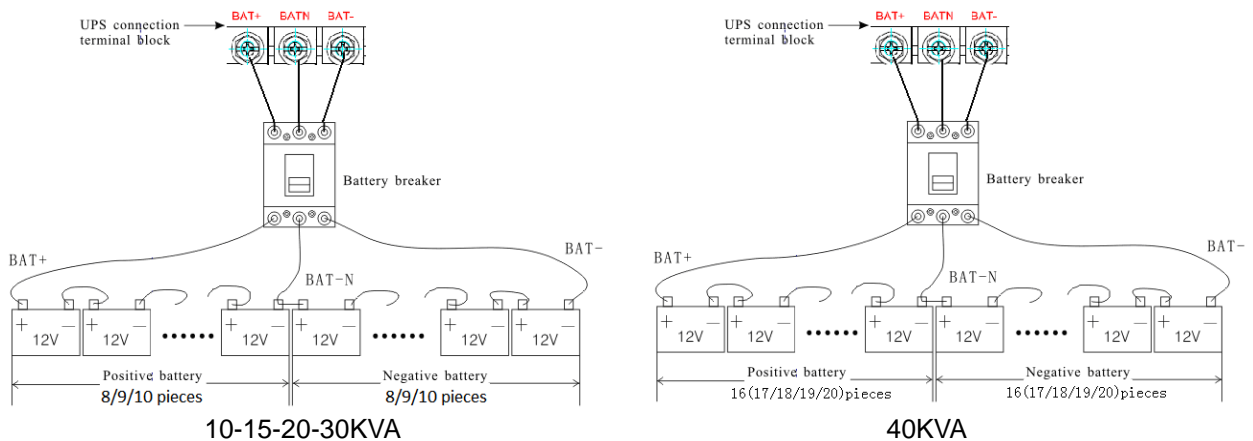

Note:

The BAT+ of the UPS connect poles is connected to the anode of the positive battery, the BAT-N is connected to the cathode of the positive battery and the anode of the negative battery, the BAT- is connected to the cathode of the negative battery.



CAUTION!

Ensure correct polarity battery string series connection. I.e. inter-tier and inter block connections are from (+) to (-) terminals. Don't mix batteries with different capacity or different brands, or even mix up new and old batteries.



WARNING!

Ensure correct polarity of string end connections to the Battery Circuit Breaker and from the Battery Circuit Breaker to the UPS terminals i.e. (+) to (+) / (-) to (-) but disconnect one or more battery cell links in each tier. Do not reconnect these links and do not close the battery circuit breaker unless authorized by the commissioning engineer.

3.9 UPS parallel Installation

The following sections introduce the installation procedures specified to the parallel system.

3.9.1 Cabinet installation

Connect all the UPS needed to be put into parallel system as below picture.

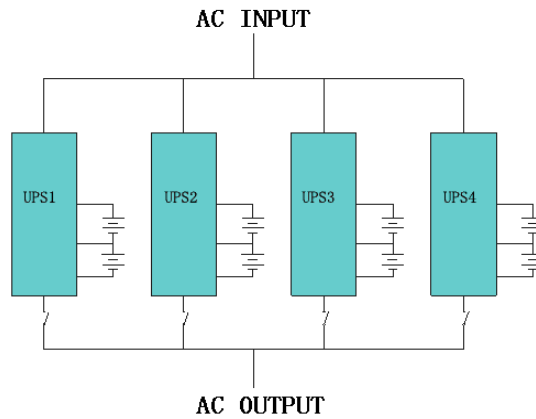

Make sure each UPS input breaker is in “off” position and there is no any output from each UPS connected. Battery groups can be connected separately or in parallel, which means the system itself provides both separate battery and common battery.



WARNING!

Make sure the N, A (L1), B (L2), C (L3) lines are correct, and grounding is well connected.

3.9.2 Parallel cable installation

Shielded and double insulated control cables available must be interconnected in a ring configuration between UPS units as shown below. The ring configuration ensures high reliability of the control.

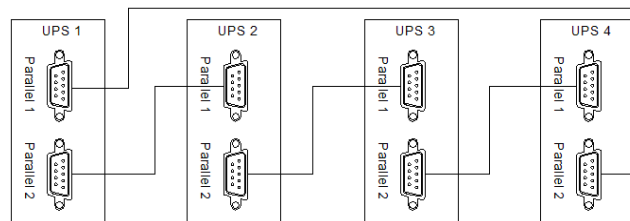

3.9.3 Requirement for the parallel system

A group of paralleled UPS behaves as one large UPS system but with the advantage of presenting higher reliability. In order to assure that all UPS are equally utilized and comply with relevant wiring rules, please follow the requirements below:

- 1) All UPS must be of the same rating and be connected to the same bypass source.
- 2) The outputs of all the UPS must be connected to a common output bus.
- 3) The length and specification of power cables including the bypass input cables and the UPS output cables should be the same. This facilitates load sharing when operating in bypass mode.

3.9.4 On screen display

3.10 Computer access (CD MUSER 4000 optional)

- ◆ One end of a USB cable connect to the computer, the other end connect to the USB port on the UPS.
- ◆ Open the software Muser4000, click “system” button.

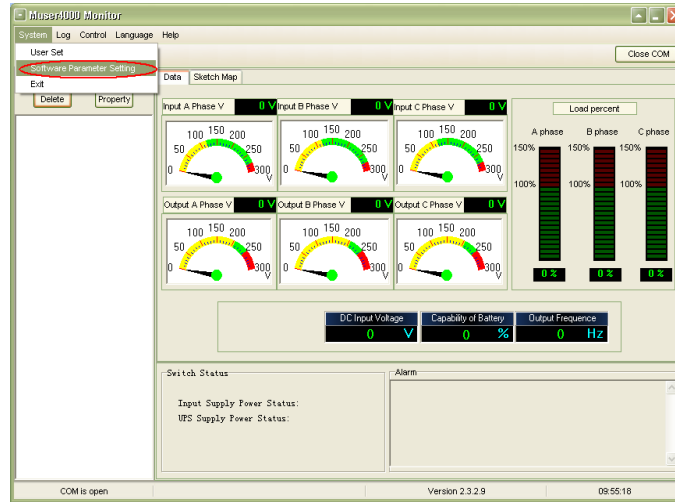

- ◆ A window of “Software Parameter Setting” comes out as below, COM choose according to the UPS, baud rate choose 9600, protocol choose “HIP”, then save this setting.

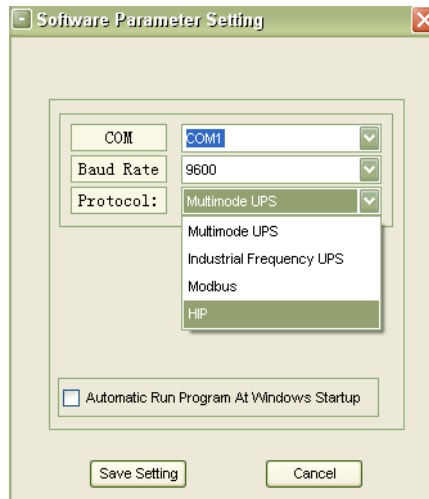

- ◆ On the main page of Muser4000, click the button of “Append”, then goes to a window of “Append equipment”.

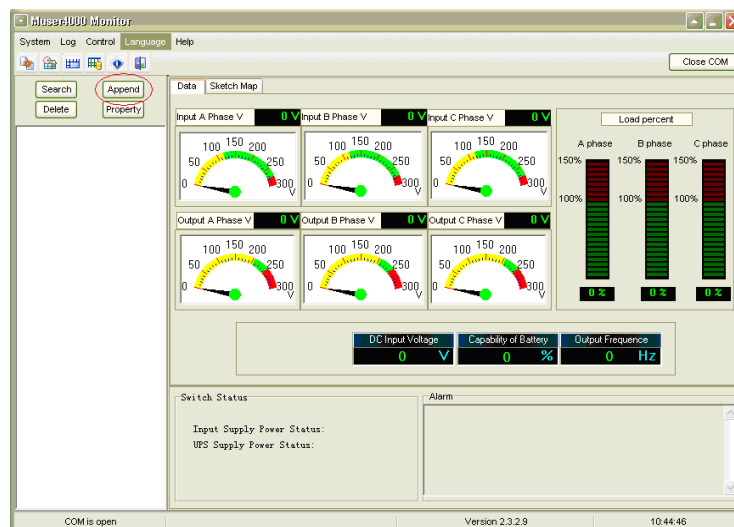

- ◆ Put the UPS name into “Equipment Name”, and UPS’ ID address into “Equipment address”.

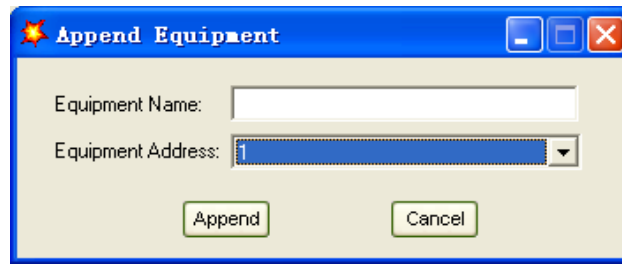

- ◆ Click the button “Append”, then the connection between UPS & computer is accomplished.



CAUTION!

When the UPS worked on inverter. If you want to use PC to set the output voltage and frequency. Must shut down the inverter first

4. OPERATION

4.1 Operation Modes

The UPS is a double-conversion on-line UPS that may operate in the following alternative modes:

- ◆ **Normal mode**

The rectifier/charger derives power from the AC Mains and supplies DC power to the inverter while floating and boosting charge the battery simultaneously. Then, the inverter converts the DC power to AC and supplies to the load.

- ◆ **Battery mode (Stored Energy Mode)**

If the AC mains input power fails, the inverter, which obtains power from the battery, supplies the critical AC load. There is no power interruption to the critical load. The UPS will automatically return to Normal Mode when AC recovers.

- ◆ **Bypass mode**

If the inverter is out of order, or if overload occurs, the static transfer switch will be activated to transfer the load from the inverter supply to bypass supply without interruption to the critical load. In the event that the inverter output is not synchronized with the bypass AC source, the static switch will perform a transfer of the load from the inverter to the bypass with power interruption to the critical AC load. This is to avoid paralleling of unsynchronized AC sources. This interruption is programmable but typically set to be less than an electrical cycle e.g. less than 15ms (50Hz) or less than 13.33ms (60Hz).

- ◆ **ECO Mode**

When the UPS is at AC Mode and the requirement to the load is not critical, the UPS can be set at ECO mode in order to increase the efficiency of the power supplied. At ECO mode, the UPS works at Line-interactive mode, so the UPS will transfer to bypass supply. When the AC is out of set window, the UPS will transfer from bypass to Inverter and supplies power from the battery, and then the LCD shows all related information on the screen.

- ◆ **Parallel redundancy mode (system expansion)**

To achieve a higher capacity and / or increase reliability, the outputs of up to four UPS can be programmed to operate in parallel and the built-in parallel controller in each UPS ensures automatic load sharing.

- ◆ **Maintenance mode (Manual Bypass)**

A manual bypass switch is available to ensure continuity of supply to the critical load when the UPS is out of order or in repair and this manual bypass switch bears for equivalent rated load.

4.2 Turn on/off UPS

4.2.1 Start procedure with Main present



CAUTION!

Make sure grounding is properly done!

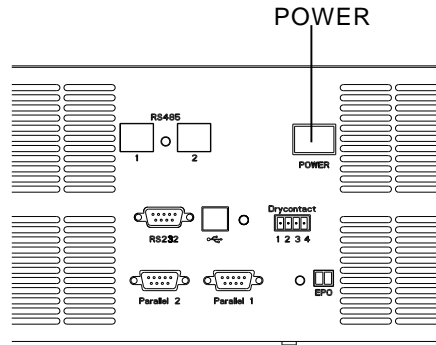

CAUTION!

Check to see if the load is safely connected with the output of the UPS. If the load is not ready to receive power from the UPS, make sure that it is safely isolated from the UPS output terminals

- ◆ Switch ON UPS output switch
- ◆ Switch ON UPS input switch

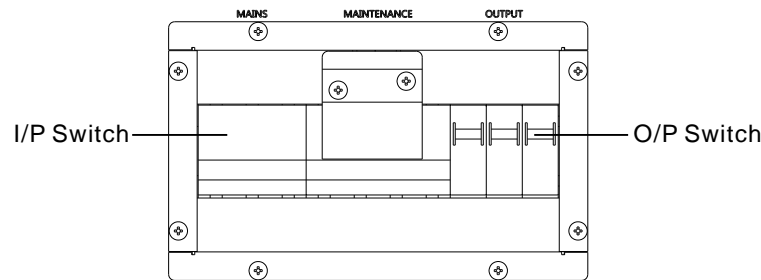

If the Rectifier input is within voltage range, the rectifier will start up in 30 seconds then the inverter will start up after then.

If the rectifier fails at startup, the bypass LED will light up. When the inverter starts up, the UPS will transfer from bypass mode to inverter mode, and then the bypass LED extinguishes and the inverter LED lights up.

All the status of the UPS will be shown on the LCD display.

4.2.2 Test procedure



CAUTION!

The UPS is operating normally. It may take 60 seconds to boost up the system and perform self-test completely.

- ◆ Switch off the MAINS to simulate utility failure, the rectifier will turn off and the battery should feed the inverter without interruption. At this time, the LED of battery should be turned on.
- ◆ Switch on the MAINS to simulate utility recovery, the rectifier will restart automatically after 20 seconds and the inverter will supply to the load. It is suggested to use Dummy loads for testing. The UPS can be loaded up to its maximum capacity during load test.

4.2.3 Maintenance Bypass

To supply the load via Mains, you may simply active the internal mechanical bypass switch.



CAUTION!

The load is not protected by the UPS when the internal mechanical bypass system is active and the power is not conditioned.

Switch to mechanical bypass

- ◆ Open the cover of maintenance switch, the UPS turns to bypass mode automatically. The Bypass LED turns on.
- ◆ Turn on MAINTANCE breaker;
- ◆ Switch OFF the MAINS breaker,
- ◆ Switch OFF OUTPUT breaker;

At this time the bypass source will supply to the load through the MAINTENANCE breaker.

Switch to normal operation (from mechanical bypass)



CAUTION!

Never attempt to switch the UPS back to normal operation until you have verified that there are no internal UPS faults.

- ◆ Switch ON the output breaker.
- ◆ Switch ON the input breaker.

The UPS powers from the static bypass instead of the maintenance bypass, then the bypass LED will light up.

- ◆ Switch OFF the maintenance bypass breaker, then the output is supplied by the static bypass of the UPS.
- ◆ Put on the maintenance switch cover.

The rectifier will operate normally after 30 seconds. If the inverter works normally, the system will be transferred from bypass mode to normal mode. Green LED turn on.

4.2.4 Cold start procedure (start up from battery)



CAUTION!

Follow these procedures when the input AC Utility Failure, but battery is normal

- ◆ Switch ON the power switch (power will feed to auxiliary power board).
- ◆ Turn on the Output switch.

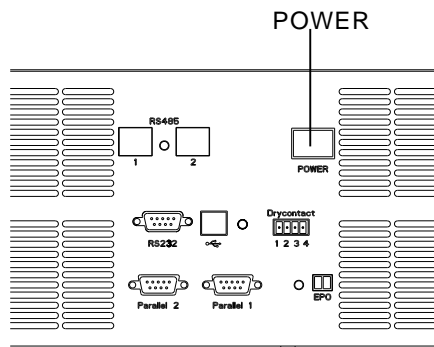

- ◆ Trigger the cold start button as the position 5 of the below drawing.

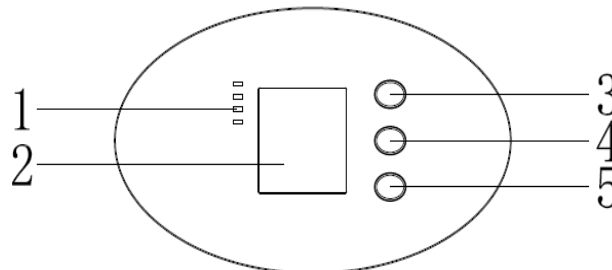

When battery normal, about 30 sec. later the inverter starts and operates and battery LED on

4.2.5 Shut down procedure



CAUTION!

This procedure should be followed to completely shut down the UPS and the LOAD. After all power switches, isolators and circuit breakers are opened, there will be no output.

- ◆ Push OFF button on the front side (4) for a few sec. the green inverter LED turn off and the yellow Bypass LED turn on.
- ◆ Switch OFF the input breaker.
- ◆ Open the OUTPUT power switch. The UPS shuts down.
- ◆ To completely isolate the UPS from AC Mains, all input switches of Utility shall be completely off, which includes the ones for rectifier and bypass.
- ◆ The primary input distribution panel, which is often located far away from the UPS area, so a label should be posted to advise service personnel that the UPS circuit is under maintenance.



WARNING!

The internal capacitors are not completely discharged.

4.2.6 Parallel setting

- ◆ Refer to chapter .4.4.10 – 4.4.11 – 4.4.12.

(with CD MUSER 4000 optional)

- ◆ Connect the UPS with computer. Power on the UPS.
- ◆ Open Muser4000 software, after connecting with the UPS successfully, click “System”->“User Set”

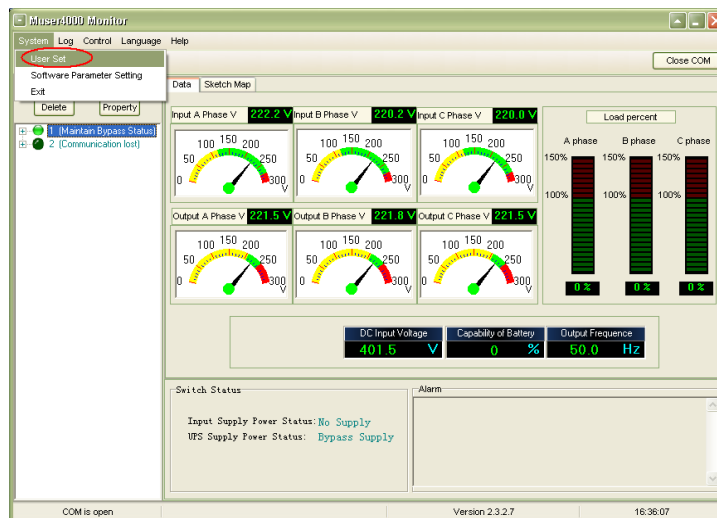

- ◆ Click “Set” at “User Set” window;

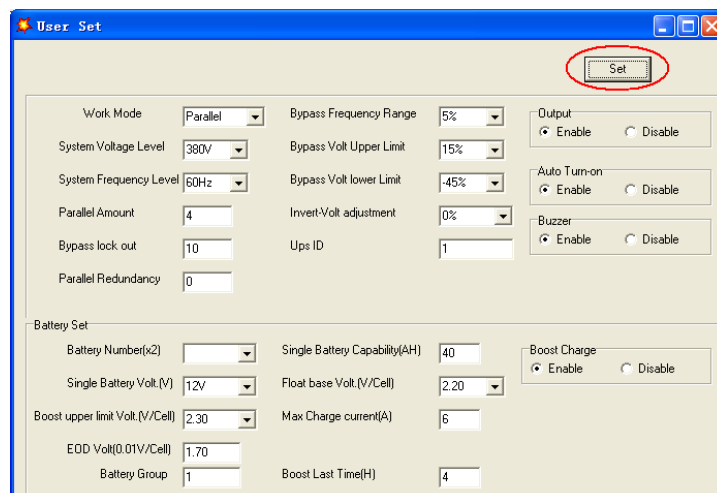

- ◆ At the window of “Data Set”, click “Work Mode”, choose “Parallel” for the value, then click “Set” as shown in below picture. If the UPS sounds a “beep”, that means the setting is correct.

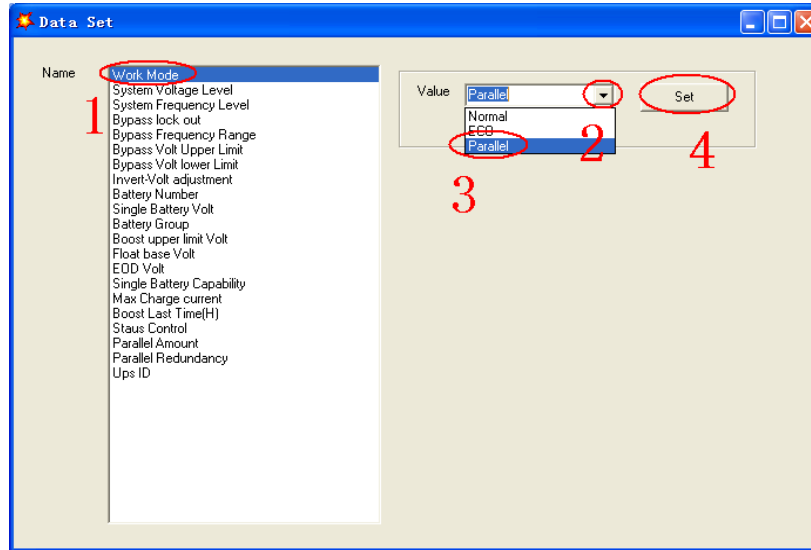

- ◆ At the window of “Data Set”, click “Ups ID”, write a value for the parallel UPS ID at the right side, such as “1”, then click “Set” as shown in below picture. If the UPS sounds a “beep”, that means the setting is correct.

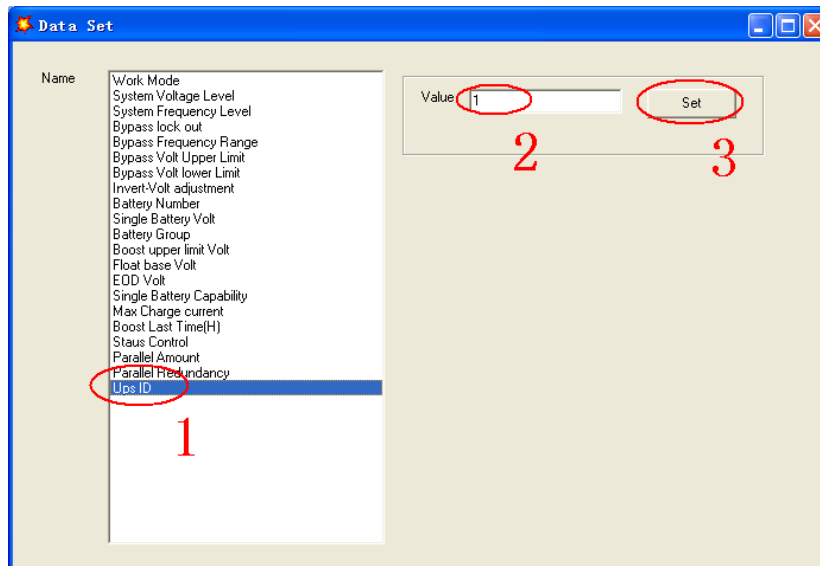

CAUTION!

After changing the parallel system ID, the connection between Muser4000 and equipment might be interrupted. If it occurs, please re-connect in accordance with the instruction described before.



CAUTION!

Parallel cable cannot be connected when setting the parallel parameters.

- ◆ After setting the UPS needed to be paralleled, power off all the UPS. Connect all the UPS according to “parallel cable installation”, and then power on the UPS.

4.3 The TFT color Display

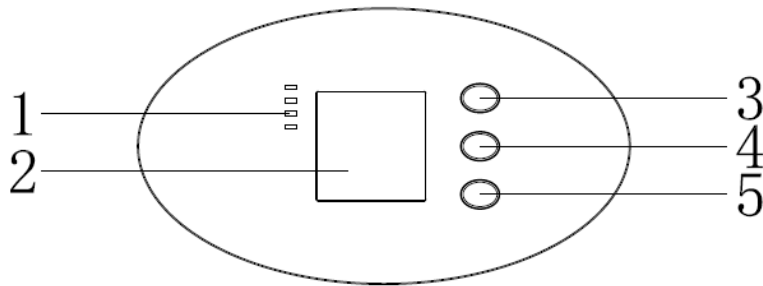

- 1) LED indicator
- 2) TFT color display
- 3) Scroll button
- 4) Off button
- 5) On button

Overview of the operating panel of the UPS

Introduction



CAUTION!

The display provides more functions than those described in this manual.

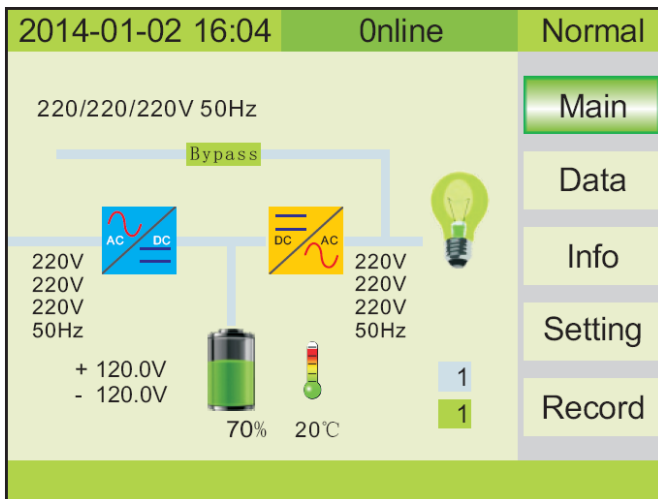

1 - Main Display

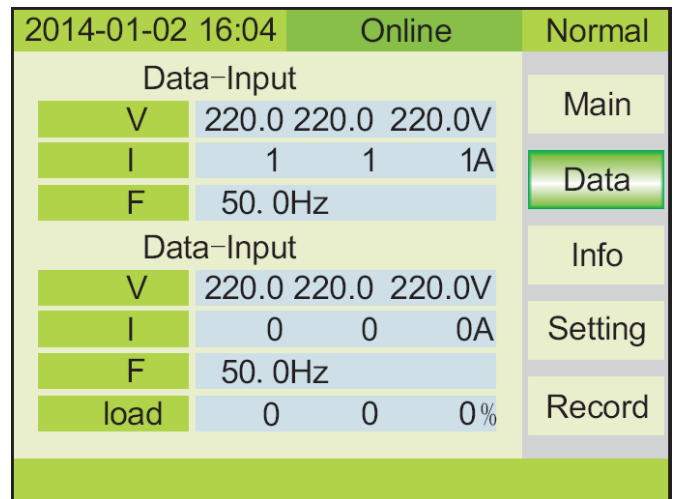

2 - Data Display

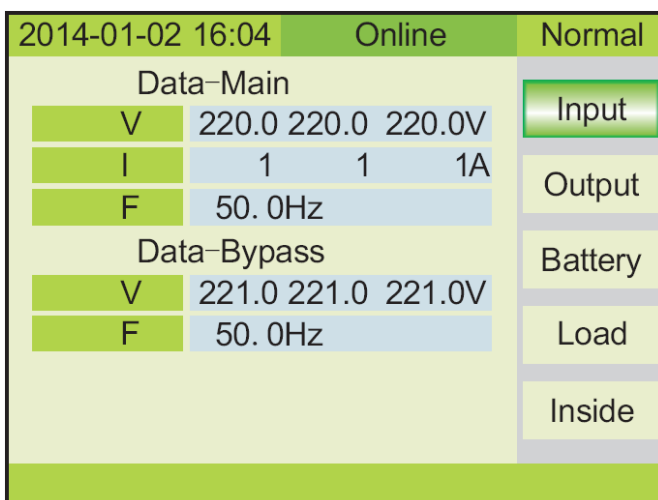

3 - Data-Input Display

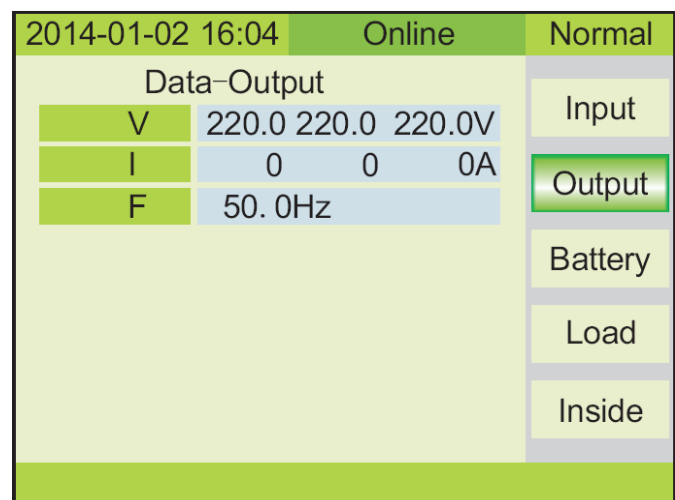

4 - Data-Output Display

2014-01-02 16:04	Online	Normal
Data-Battery		
V	+120.0 -120.0V	Input
I	2 2A	Output
Time	120 120min	Battery
CaP.	70 70%	Load
		Inside

5 - Data-Battery Display

2014-01-02 16:04	Online	Normal
Data-Load		
%	0 0 0%	Input
P	0 0 0kW	Output
S	0 0 0kVA	Battery
		Load
		Inside

6 - Data-Load Display

2014-01-02 16:04	Online	Normal
Data-Inside		
V-Bus	+370 -370V	Input
T1/T2	PFC:42 INV:46°C	Output
V-Inv	220 220 220V	Battery
F-Inv	50Hz	Load
		Inside

7 - Data-Inside Display

2014-01-02 16:04	Online	Normal
Information		
LCD Ver.	V004B001D000	Main
PFC Ver.	V001B345D000	Data
INV Ver.	V001B345D000	Info
		Setting
		Record

8 - Info Display

2014-01-02 16:04	Online	Normal
Setting-User		
Lang.	English	Main
Date	2014-01-02	Data
Time	16:04	Info
Backlight	60s	Setting
Buzzer	Disable	Record
Test Now	OFF / 10s / 10min / EOD	

9 - Setting-User Display

2014-01-02 16:04:55	Online	Fault
Record-Event		
Time	14-01-01 16:04:05	Main
State	Initialize	Data
Record-Fault		
Time	14-01-02 16:04:05	Info
Alarm	INV Over Temperature	Setting
		Record
INV Over Temperature		

10 - Record Display*

MBT (Manual Battery Test)

FROM UPS TFT DISPLAY:

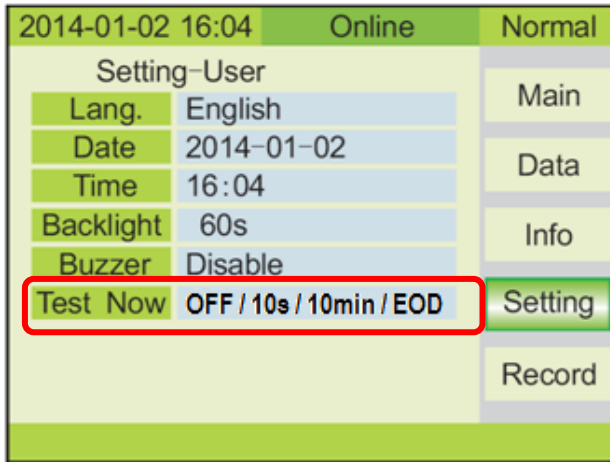

Enter in "9 - Setting-User display" select between the choices in the "Test Now" Menu.

- OFF = No Test
- 10s = Test for 10s
- 10min = Test for 10Min
- EOD = Test until End Of Discharge

WITH SOFTWARE MUSER4000:

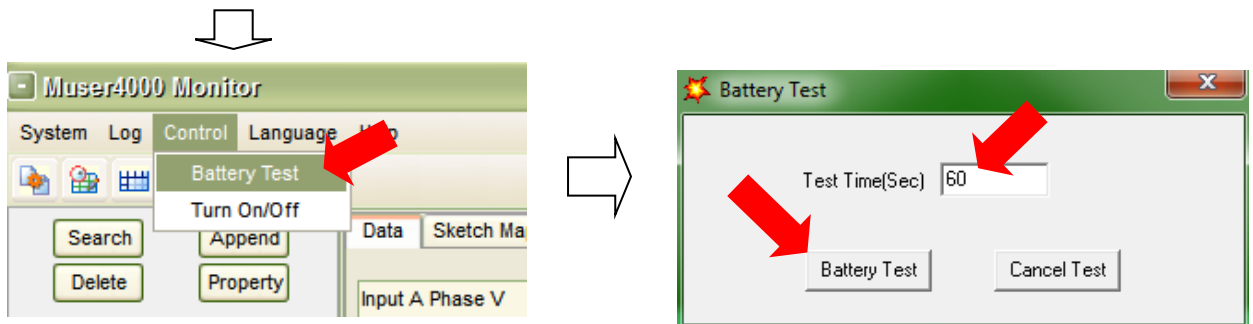
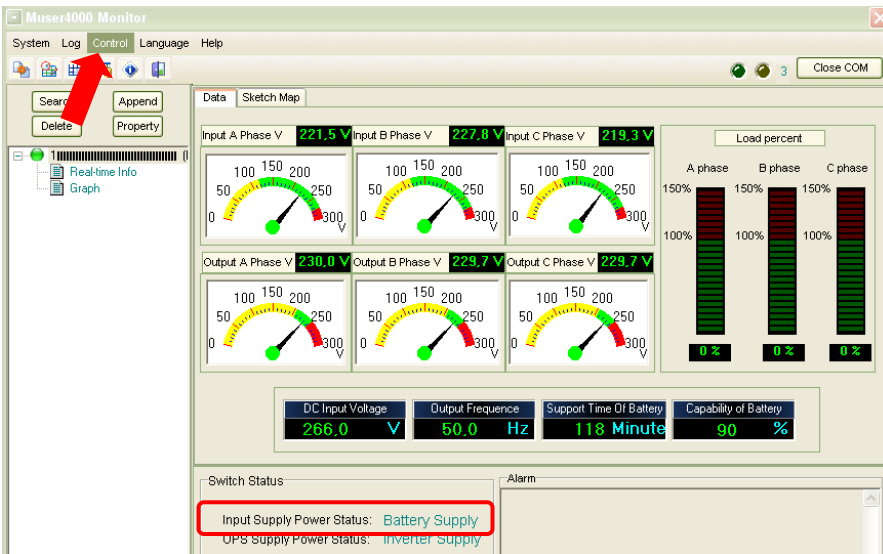

After setting "Test Time" push Battery Test and immediately the Battery test start. The yellow Battery Led turn on and buzzer "bip" 1 per sec. On the Muser monitor (show in red square) there is: Battery Supply indication. When the test finish the battery Led turn off and the Inverter Green led turn on, the buzzer silence and in the Muser monitor will be indicate Mains Supply.

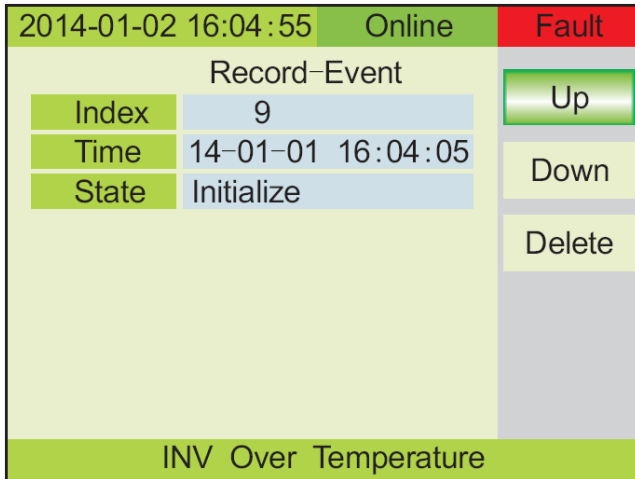

11 - Record- Event Display

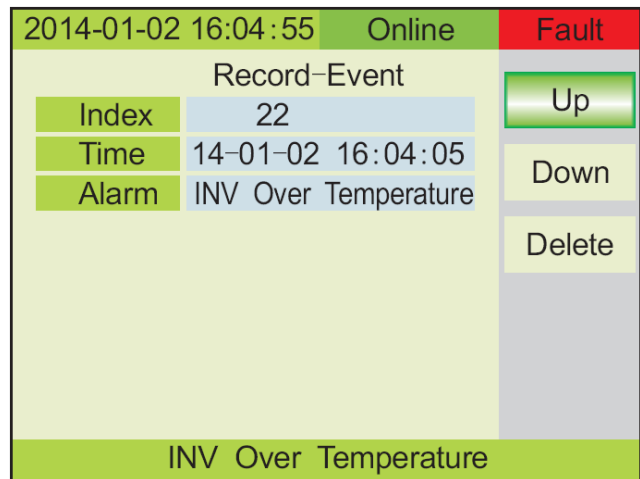

12 - Record- Fault Display

(Max 2000 records of alarm can be available)

N.b.: Is possible to reset completely all the records of the events choosing "DELETE". Only Authorized technicians that have the password can do this operation.

4.4 Parameters Display & Setting

The following describe the functions of the buttons to perform the display and parameter setting UPS:

BUTTON	FUNCTION	AVAILABLE	
SELECT	Short press for selecting Long press for log out	USER	AUTHORIZED TECHNICIANS
OFF	Short press to confirmation Long press to turn OFF the Inverter (on main menu)		
ON	Long press to turn ON the Inverter		
SELECT + OFF	If you press this key combination in the setting page,you can enter into the input interface for maintenance password. (restricted only for authorized technicians)		

USERS INTERFACE:

Available views at the user level are those described in section 4.3 (pictures 1 to 12). The enable settings are those shown in picture 9.

AUTHORIZED TECHNICIANS INTERFACE:

Available to technicians and authorized service center, in possession of the password, there is the possibility to access at the maintenance and advanced settings interface (picture 13) by pressing the key combination "SELECT + OFF" when you are in the mask shown in picture 9.

Below are described some of the functions available:

- SYSTEM (Work mode-SINGLE-PARALLEL-ECO, V Output, Frequency, ecc.)
- BYPASS (Upper/Lower Limit, Range)
- BATTERY (Number, Capacity, I Max charge ecc.)
- PARALLEL (ID, Number Unit, Redundance, ecc.)

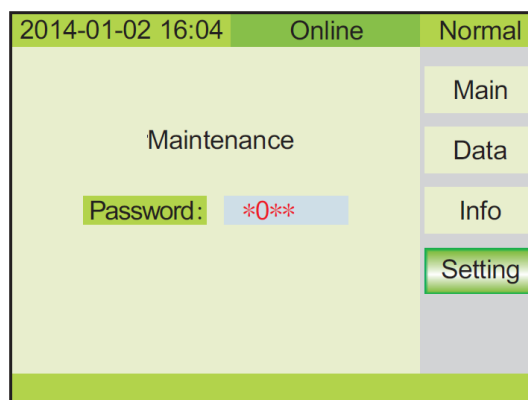

13 – Maintenance interface

ABT (Automatic Battery Test)

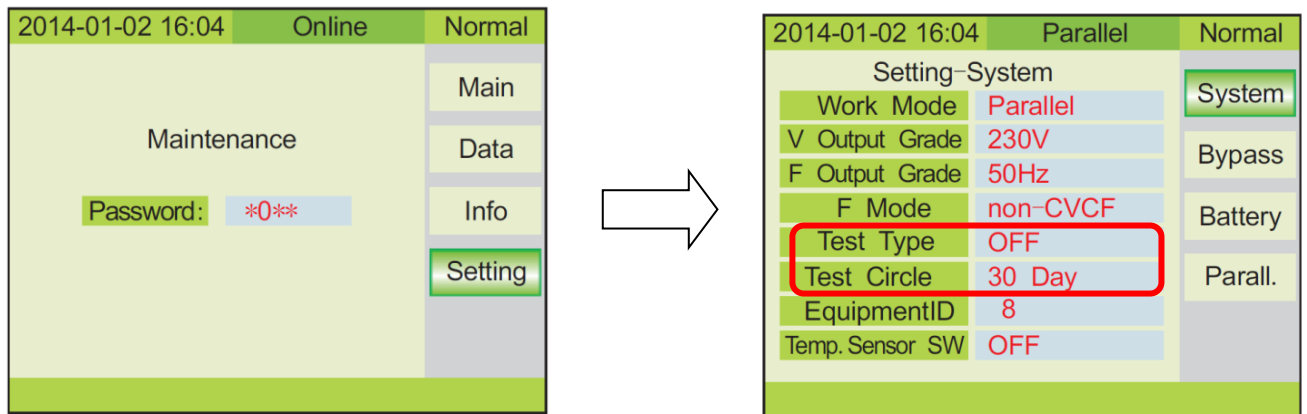

For setup the ABT function is necessary have a password to enter in the setting system menu. The choices are:

for Test Type:

- OFF = No Test
- 10s = Test for 10s
- 10min = Test for 10Min
- EOD = Test until End Of Discharge

for Test Circle:

1day to 60days

If the Test Battery fail (MBT/ABT):

- The Ups goes to Bypass
- Battery Led blinking every 1 sec
- Buzzer bip every 1 sec
- Display message: Fault / Battery EOD

If the Test Battery is setting for 10min and backup time is lower than 10 min (MBT/ABT):

- Battery Led blinking
- Display message: Fault / Bat Low pre-warning

- The Ups goes to Inverter mode
- Battery Led blinking every 1 sec
- Buzzer bip every 1 sec
- Display message: Fault / Battery EOD

Until the battery charge percentage reach about 43% then only the green inverter Led is ON

WRONG ROTARY FIELD (Input main wrong connection)

When you turn On the UPS and the input phase is in wrong connection we have this situation:

- Red Led (fault) blinking every 1 sec
- Yellow Led (bypass) blinking every 1 sec
- Buzzer bip continuous
- Display message: Fault / Bypass not available / INPUT PHASE REVERSE
- Green Led (inverter) on.



DATE SETTING

To set the correct date/hour go to the Date menu.

ATTENTION: if the UPS stays off for more than three days, the settings will be lost and will return to the factory settings.

4.5 Display Messages/Troubleshooting

This section lists the event and alarm messages that the UPS might display. The messages are listed in alphabetical order. This section is listed with each alarm message to help you troubleshoot problems.

Display messages - Operational Status and Mode(s)

N°	UPS STATUS	LED			
		FAULT	BYPASS	BATTERY	INVERTER
1	Initialized	OFF	OFF	OFF	OFF
2	Standby Mode	OFF	OFF	X	OFF
3	No Output	OFF	OFF	X	OFF
4	Bypass Mode	OFF	ON	X	OFF
5	Utility Mode	OFF	OFF	X	ON
6	Battery Mode	OFF	OFF	ON	OFF
7	Battery Self-diagnostics	OFF	OFF	ON	OFF
8	Inverter is starting up	OFF	X	X	OFF
9	ECO Mode	OFF	X	X	X
10	EPO Mode	ON	OFF	X	OFF
11	Maintenance Bypass Mode	OFF	OFF	OFF	OFF
12	Fault Mode	ON	X	X	X

CAUTION: "X" means it is determined by other conditions

Display Messages - Alarm Information

UPS ALARM WARNING	BUZZER	LED
Rectifier Fault	Beep continuously	Fault LED lit
Inverter fault (Including Inverter bridge is shorted)	Beep continuously	Fault LED lit
Inverter Thyristor short	Beep continuously	Fault LED lit
Inverter Thyristor broken	Beep continuously	Fault LED lit
Bypass Thyristor short	Beep continuously	Fault LED lit
Bypass Thyristor broken	Beep continuously	Fault LED lit
Fuse broken	Beep continuously	Fault LED lit
Parallel relay fault	Beep continuously	Fault LED lit
Fan fault	Beep continuously	Fault LED lit
Reserve	Beep continuously	Fault LED lit
Auxiliary power fault	Beep continuously	Fault LED lit
Initialization fault	Beep continuously	Fault LED lit
P-Battery Charger fault	Beep continuously	Fault LED lit
N-Battery Charger fault	Beep continuously	Fault LED lit
DC Bus over voltage	Beep continuously	Fault LED lit
DC Bus below voltage	Beep continuously	Fault LED lit
DC bus unbalance	Beep continuously	Fault LED lit
Soft start failed	Beep continuously	Fault LED lit
Rectifier Over Temperature	Twice per second	Fault LED lit
Inverter Over temperature	Twice per second	Fault LED lit
Reserve	Twice per second	Fault LED lit
Battery reverse	Twice per second	Fault LED lit

Cable connection error	Twice per second	Fault LED lit
CAN comm. Fault	Twice per second	Fault LED lit
Parallel load sharing fault	Twice per second	Fault LED lit
Battery over voltage	Once per second	Fault LED blinking
Mains Site Wiring Fault	Once per second	Fault LED blinking
Bypass Site Wiring Fault	Once per second	Fault LED blinking
Output Short-circuit	Once per second	Fault LED blinking
Rectifier over current	Once per second	Fault LED blinking
Bypass over current	Once per second	BPS LED blinking
Overload	Once per second	INV or BPS LED blinking
No battery	Once per second	Battery LED blinking
Battery under voltage	Once per second	Battery LED blinking
Battery low pre-warning	Once per second	Battery LED blinking
Internal Communication Error	Once per 2 seconds	Fault LED blinking
DC component over limit.	Once per 2 seconds	INV LED blinking
Parallel Overload	Once per 2 seconds	INV LED blinking
Mains volt. Abnormal	Once per 2 seconds	Battery LED lit
Mains freq. abnormal	Once per 2 seconds	Battery LED lit
Bypass Not Available		BPS LED blinking
Bypass unable to trace		BPS LED blinking
Inverter on invalid		
Reserve		
inverter not on		

4.6 Options

SNMP card: internal SNMP / external SNMP

- ◆ Loosen the 2 torque screws (on each side of the card).
- ◆ Carefully pull out the card. Reverse the procedure for re-installation

The slot called SNMP supports the MEGAtec protocol. We advise that NetAgent II-3 port is also a tool to remotely monitor and manage any UPS system

NetAgent II-3Ports supports the Modem Dial-in (PPP) function to enable the remote control via the internet when the network is unavailable.

In addition to the features of a standard NetAgent Mini, NetAgent II has the option to add NetFeeler Lite to detect temperature, humidity, smoke and security sensors. Thus, making NetAgent II a versatile management tool. NetAgent II also supports multiple languages and is setup for web-based auto language detection.

RELAY card

Dry contact card provide dry contacts for UPS external monitoring, and tell the UPS operation status. Dry contact card provide 10 connectors for users, 7 outputs for indicating UPS status, 1 for common ground, 2 input for remote UPS shut down.



SNMP Card



RELAY Card

SNMP Configuration Type

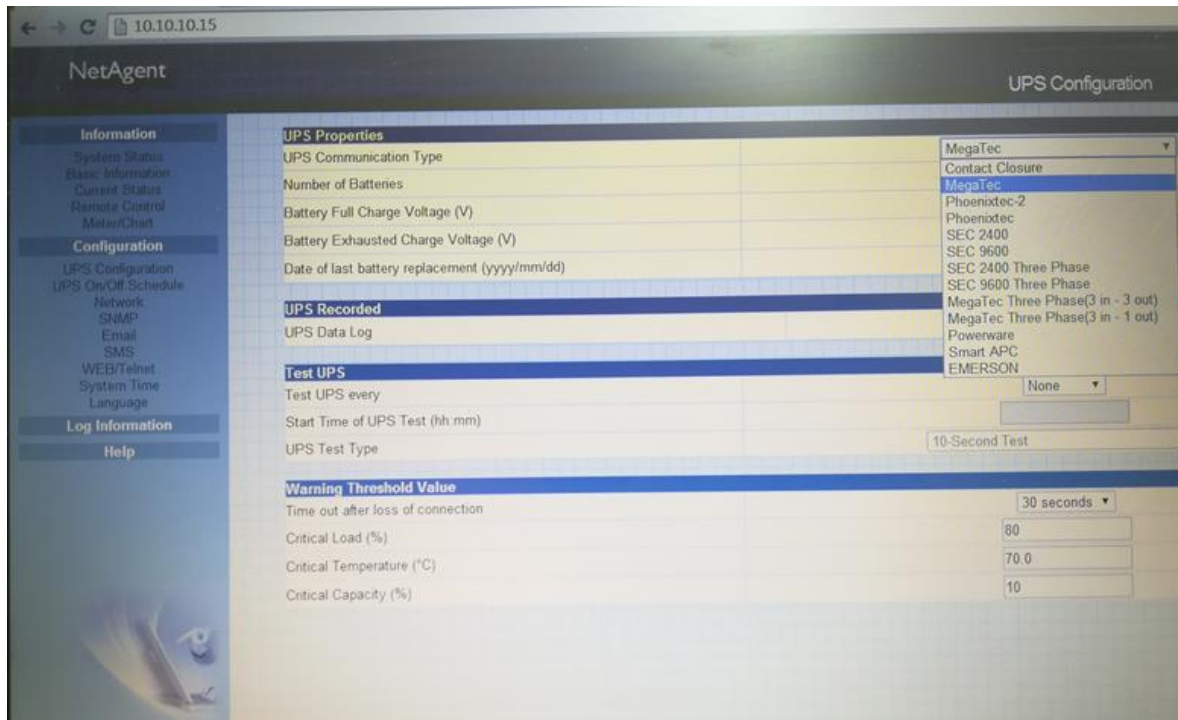

To select the correct communication type, enter in Configuration / Ups Configuration and select MegaTec Three Phase (3in - 3out) drop down menu and apply before exit.

APPENDIX 1: SPECIFICATIONS

MODEL		SWITCHBOARD 10	SWITCHBOARD 15	SWITCHBOARD 20	SWITCHBOARD 30	SWITCHBOARD 40	
Input	Capacity	10KVA 10KW	15KVA 15KW	20KVA 20KW	30KVA 30KW	40KVA 40KW	
	Phase	3 Phase 4 Wires and Ground					
	Rated Voltage	380/400/415Vac					
	Voltage Range	208~478Vac					
	Frequency Range	45-55Hz a 50Hz / 56-66Hz a 60Hz (auto sensing)					
	Power Factor	≥0.99					
	Current THDi	≤2%(100% non linear load)					
	Bypass Voltage Range	Max Voltage.: 220Vac:+25% (optional +5%,+10%,+15%) 230Vac:+20% (optional +10%,+15%) 240Vac:+15% (optional +10%) Min. Voltage.: -45% (optional -20%、-30%) Frequency protection range: ±10%					
	Generator Input	Supported					
Output	Phase	3 Phase 4 Wires and Ground					
	Rated Voltage	380/400/415Vac					
	Power Factor	1.0					
	Voltage Regulation	±1%					
	Frequency	Utility Mode	±1%、±2%、±4%、±5%、±10% of the rated frequency (optional)				
		Battery Mode	(50/60±0.1%)Hz				
	Crest Factor	3:1					
THD	≤1% with linear load ≤3% with non linear load						
Efficiency (in normal mode)		≥96,5%	≥97,5%				
Battery	Voltage	Standard UPS: ±120Vdc (10+10) 12V 7/9AH Long run backup UPS ±96V/±108V/±120Vdc (16/18/20 pz. optional)				Standard UPS: ±240Vdc (20+20) 12V 7/9AH Long run backup UPS: ±192/±204/±216/±228/±240Vdc (32/34/36/38/40 pz optional)	
	Charge Current (A)	Charge current is automatically set in according to the capacity and the quantity of the batteries Standard UPS (20pcs): 1,35A Standard UPS (2X20pcs): 2,7A Standard UPS (3X20pcs): 4,5A Long run backup UPS: max 10A					
	Battery Test	Supported					
Transfer Time		Utility to Battery: 0ms Utility to bypass: 0ms					

MODEL		SWITCHBOARD 10	SWITCHBOARD 15	SWITCHBOARD 20	SWITCHBOARD 30	SWITCHBOARD 40	
Protection	Overload	AC Mode	Load ≤ 110%: last 60min, ≤ 125%: last 10min, ≤ 150%: last 1min, ≥ 150% change to bypass immediately				
		Battery Mode	Load ≤ 110%: last 10min, ≤ 125%: last 1min, ≤ 150%: last 10s, ≥ 150% shut down UPS immediately				
		Bypass Mode	Breaker 20A	Breaker 32A	Breaker 40A	Breaker 63A	Breaker 80A
	Short Circuit		Involves the whole UPS				
	Overheat		Line Mode: Switch to Bypass, Backup Mode: Shut down UPS immediately				
	Battery Low		Alarm and switch off UPS				
	Self-diagnostics		Upon Power On and Software Control				
	EPO (optional)		Shut down UPS immediately				
	Battery		Advanced Battery Management				
	Noise Suppression		Complies with EN62040-2				
Alarms	Audible & Visual	Line Failure, Battery Low, Overload, System Fault					
Display	Status LED & LCD	Line Mode, Bypass Mode, Battery Low, Battery Bad, Overload & UPS Fault					
	Reading on the LCD	Input Voltage, Input Frequency, Output Voltage, Output Frequency, Load Percentage, Battery Voltage & Inner Temperature etc.					
Communication Interface		USB, RS485, Parallel (optional), Coupler dry contact, Intelligent slot, SNMP card (optional), Relay card (optional)					
Environment	Operating Temperature	0°C~40°C					
	Storage Temperature	-25°C~55°C					
	Humidity	0~95% non condensing					
	Altitude	< 1500m When >1500m lower the rated power for use					
	Noise	< 55dB				< 58dB	
Other	Dimensions (D×W×H)	283x470x705 283x520x705 (included fixing brackets)					
	Weight (Kg) (without batteries)	47	53	54	60	62	
	N° of unit	1					
Safety Conformance		IEC/EN 62040-1, IEC/EN 62040-2, IEC/EN 62040-3, EN60950-1					
Frequency Converter function		Yes					

APPENDIX 2: PROBLEMS AND SOLUTION

In case the UPS cannot work normally, it might be wrong in installation, wiring or operation. Please check these aspects first. If all these aspects are checked without any problem, please consult with local agent right away and provide below information:

- 1) Product model name and serial number.
- 2) Try to describe the fault with more details, such as LCD display info, LED lights status, etc.

Read the user manual carefully, it can help a lot for using this UPS in the right way.

Some FAQ (frequently asked questions) may help you to troubleshoot your problem easily.

N°	PROBLEM	POSSIBLE REASON	SOLUTION
1	Utility is connected but the UPS cannot be powered ON.	Input power supply is not connected Input voltage low The input switch of the UPS is not switched on	Measure if the UPS input voltage/frequency is within the window Check if UPS input is switched on
2	Utility normal but Utility LED does not light on and the UPS operates at battery mode	Input breakers of the UPS are not switched on Input cable is not well connected	Switch on the input breaker Make sure the input cable is well connected
3	The UPS does not indicate any failure but output do not have voltage	Output cable does not well connected Output breaker do not switch on	Make sure the output cable is well connected Switch on the output breaker
4	Utility LED is flashing	Utility voltage exceeds UPS input range	If the UPS operates at battery mode, please pay attention to the remaining backup time needed for your system
5	Battery LED is flashing but no charge voltage and current	Battery breaker does not switch on or batteries are damaged, or battery is reversely connected Battery number and capacity are not set correctly	Switch on the battery breaker. If batteries are damaged, need to replace whole group batteries Connect the battery cables correctly Go to LCD setting of the battery number and capacity and set the correct data
6	Buzzer beeps every 0.5 seconds and LCD display "fault / overload"	Overload	Remove some load
7	The UPS only works on bypass mode	The UPS is set to ECO mode or the transfer times to bypass mode are limited	Set the UPS working mode to UPS type (non-parallel) or to reset the times of transferring to bypass or re-start the UPS
8	Cannot Cold start	Battery switch is not properly closed Battery fuse is open Battery low Battery quantity set wrong Power breaker in the rear panel not switch ON	Close the battery switch Change the fuse Recharge the battery Power ON the UPS with AC to set the battery quantity & quantity Switch on the power breaker

APPENDIX 3: USB COMMUNICATION PORT DEFINITION

Definition of port - Connection between PC USB port and UPS USB port:

PC USB PORT	UPS USB PORT	SIGNAL DESCRIPTION
Pin 1	Pin 1	PC: +5V
Pin 2	Pin 2	PC: DPLUS Signal
Pin 3	Pin 3	PC: DMINUS Signal
Pin 4	Pin 4	Signal Ground

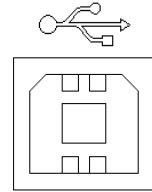

Available function of USB port:

- ◆ Monitor UPS power status.
- ◆ Monitor UPS alarm info.
- ◆ Monitor UPS running parameters.
- ◆ Timing off/on setting.

Communication data format

Baud rate: 9600bps
 Byte length: 8bit
 End bit: 1bit
 Parity check: none



CAUTION!

USB, RS232 and RS485 interface cannot be used at the same time, you can only use one of them at one time.

APPENDIX 4: RS232 COMMUNICATION PORT DEFINITION

Definition of Male port - Connection between PC RS232 port and UPS RS232 port:

PC RS232 PORT	UPS RS232 PORT	SIGNAL DESCRIPTION
Pin 2	Pin 2	UPS send - PC receive
Pin 3	Pin 3	PC send - UPS receive
Pin 5	Pin 5	Signal Ground

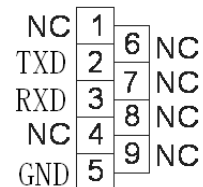

Available function of RS232 port:

- ◆ Monitor UPS power status.
- ◆ Monitor UPS alarm info.
- ◆ Monitor UPS running parameters.
- ◆ Timing off/on setting.

RS-232 communication data format

Baud rate: 9600bps
 Byte length: 8bit
 End bit: 1bit
 Parity check: none



CAUTION!

USB, RS232 and RS485 interface cannot be used at the same time, you can only use one of them at one time.

APPENDIX 5: RS485 COMMUNICATION PORT DEFINITION

Definition of port - Connection between the Device's RS485 port and UPS RS485 port:

DEVICE (RJ45)	UPS (RJ45)	SIGNAL DESCRIPTION
Pin 1/5	Pin 1/5	485 + "A"
Pin 2/4	Pin 2/4	485 - "B"
Pin 7	Pin 7	+12Vdc
Pin 8	Pin 8	GND

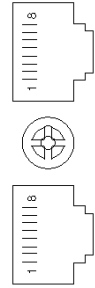

Available function of RS485 port:

- ◆ Monitor UPS power status.
- ◆ Monitor UPS alarm info.
- ◆ Monitor UPS running parameters.
- ◆ Timing off/on setting.
- ◆ Battery environment temperature monitoring.
- ◆ Charging voltage modulation depending on batteries temperature.



CAUTION!

USB, RS232 and RS485 interface cannot be used at the same time, you can only use one of them at one time.

APPENDIX 6: OPTOCOUPLER CONTACT COMMUNICATION PORT DEFINITION

Definition of Male port - Instruction:

UPS	INSTRUCTION	STATUS
Pin 1	UPS Battery Low	Normally Open
Pin 2	AC Power Failure	Normally Open
Pin 3	Turn off Inverter	Normally Open
Pin 4	GND	Normally Open

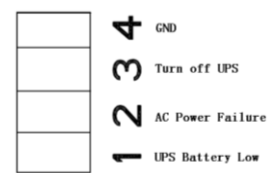

Function description:

- ◆ Monitor UPS status;
- ◆ Monitor UPS battery status;
- ◆ Shutdown UPS.

Vdc	I
0-25V (max)	6mA (max)

APPENDIX 7: REPO INSTRUCTION

Definition of port - Connection diagram - Connection between the button and UPS REPO port:

BUTTON	UPS REPO	DESCRIPTION
Pin 1	Pin 1	EPO
Pin 2	Pin 2	GND

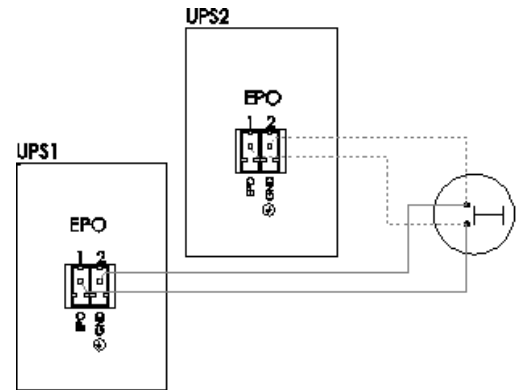

- ◆ A remote emergency stop switch (Dry contact signal and “normally open” - not provided) can be installed in a remote location and connection through simple wires to the REPO connector.
- ◆ The remote switch can be connected to several UPS in a parallel architecture allowing the user to stop all units at once.

APPENDIX 8: ACCESSORIES

Check if the following accessories are present in the packaging:

TYPE	POLARIS 10-160
User Manual	●
Software MUSER4000 (CD)	○
USB Cable	●
EPO Connector	●

● present ○ optional

APPENDIX 9: EFFICIENCY CHART

Below the table and graphics for efficiency data:

Load \ Model	10kVA	15kVA	20kVA	30kVA	40kVA
25%	94,9	97,2	97,3	96,8	97,1
50%	96,5	97,5	97,5	97,5	97,5
75%	96,9	97,5	97,5	97,6	97,5
100%	96,9	97,7	97,7	97,6	98,3

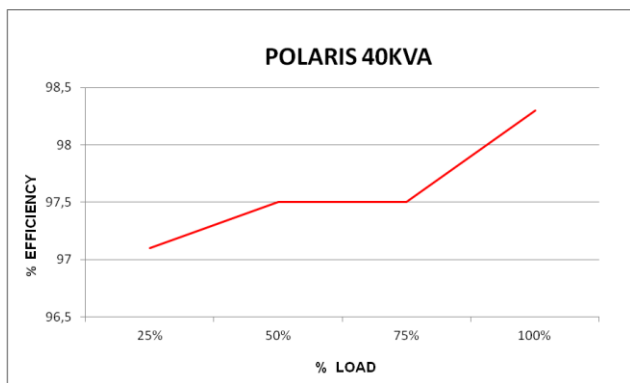
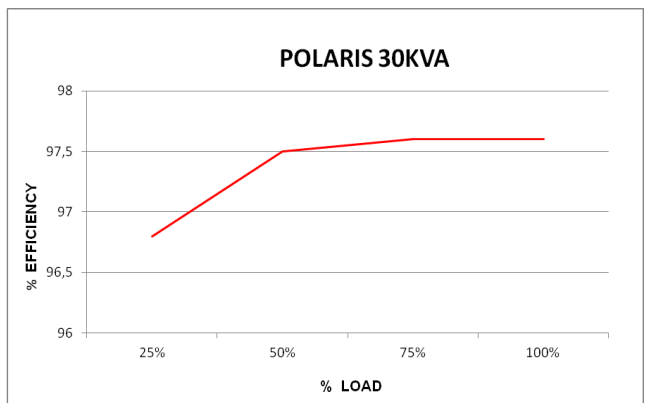
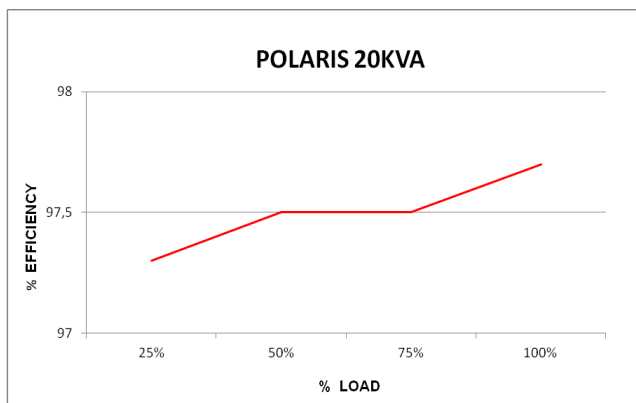
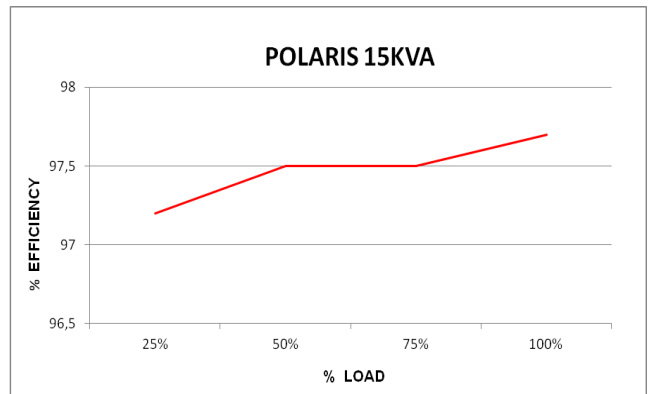
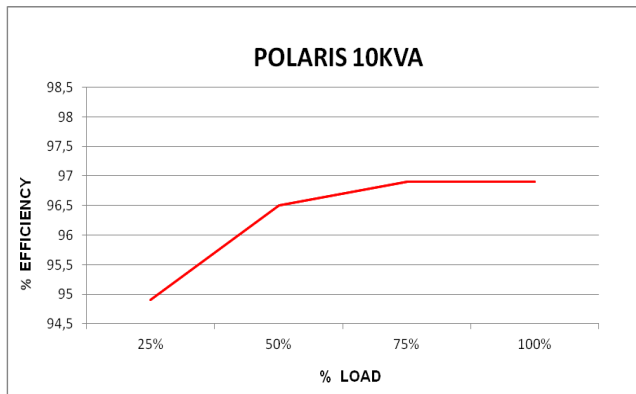

WARRANTY

Dear Customer,

Thank you for purchasing a NAICON product. We hope that you be satisfied.

If the product fails in warranty period, please contact your dealer or call +39 02 950031 or go to www.naicon.com/elsist. Before contacting your dealer or authorized service network, we recommend that you read the operating and maintenance manual carefully.

With this warranty, NAICON warrants the product to be free from defective in materials or workmanship for 24 months on electronics and 12 months on batteries, as of the original delivery date.

If there are material or manufacturing defects during the warranty period, ELSIST affiliates, Authorized Service Centers or authorized resellers located in the UE region will repair or (at ELSIST discretion) replace the defective product or components under the terms and conditions below, without any charge for labor or spare parts costs. ELSIST reserves the right (in its sole discretion) to replace the components of defective products or low cost products with assembled parts or new or refurbished products.

Conditions.

1. This warranty will be valid only if the defective product is returned together with the sales invoice.

ELSIST reserves the right to refuse warranty service in the absence of such documents or if the information contained therein is incomplete or illegible.

2. This warranty does not cover the costs and / or any damages and / or defects resulting from any modifications or adjustments made to the product, without prior written permission from ELSIST, in order to adapt the product to local technical or safety standards in countries other than those for which the product was originally designed and manufactured.

3. This warranty will be void if the model or serial number indicated on the product has been modified, deleted, removed or otherwise illegible.

4. Are excluded from the warranty:

- Periodic maintenance and repair or replacement of parts subject to normal wear and tear.
- Any modification or modification to the product, without prior written permission from ELSIST to enhance performance than those described in the User and Maintenance Manual
- All costs of technical staff support and any transport from the customer's address to Assistance Center and vice versa as well as all the risks involved.
- Damages due to:
 - a. Improper use, including but not limited to: (a) the use of the product for any purpose other than the intended use or failure to observe the ELSIST instructions for correct use and maintenance of the product, (b) installation or use of the product not complying with the Technical or Safety standards in the country in which it is used.
 - b. Repairs by unauthorized personnel or by the Customer himself.
 - c. Accidental events, lightning, floods, fires, incorrect ventilation or other causes not attributable to ELSIST.
 - d. Defects of the equipment or equipment to which the product was connected.

5. This warranty does not affect the buyer's rights established by applicable national laws nor the Customer's rights to the reseller arising out of the sales contract.

Unless authorized by the manufacturer, reproduction of any part of this manual is prohibited. Our equipment, built with the utmost care and with selected components, is controlled by ELSIST Quality Services. However, if you notice any anomalies, please inform us by calling +39 02-950031 specifying serial number and model of the device, which are printed on the identification plate at the rear side of the UPS. ELSIST Assistance Service is also available to collect requests, comments, suggestions, if any.

In case of failure:

Contact our Customer Service Center at +39 02 95 0031, and verify the UPS malfunction.

If the products returned to NAICON were OPERATING or if they were delivered without our permission or for out-of-warranty products, they will be returned to the customer by charging a cost that will depend on the country where will be shipped.

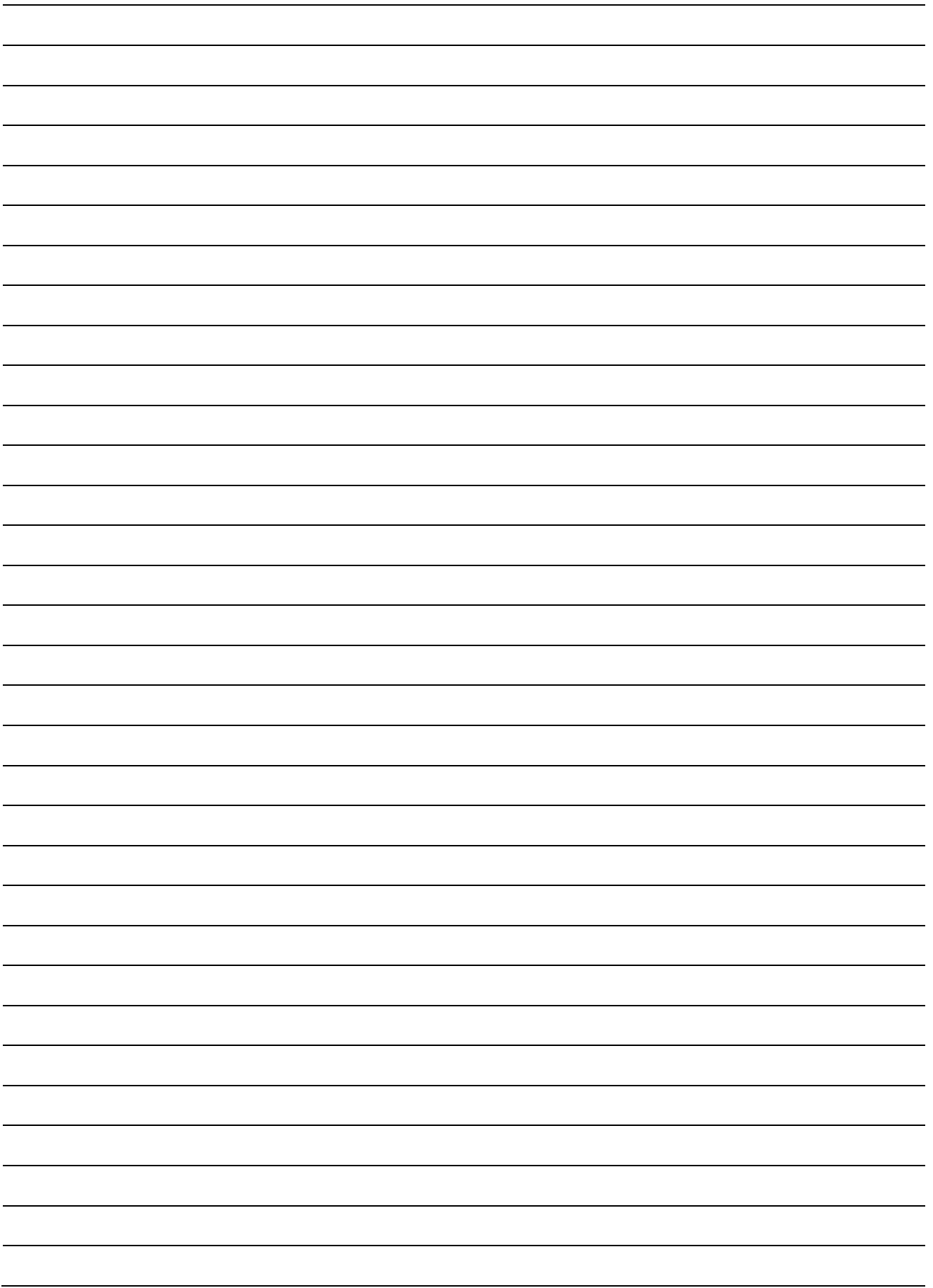



 **NaiconGroup**

Naicon srl Via il Caravaggio, 25 Trecella
I-20060 Pozzuolo Martesana - Milano (Italy)
Tel. +39 02 95.003.1 Fax +39 02 95.003.313
www.naicon.com e-mail: naicon@naicon.com